

TASCAM

TEAC Professional Division

9101441900

X-9

Professional Digital DJ Mixer

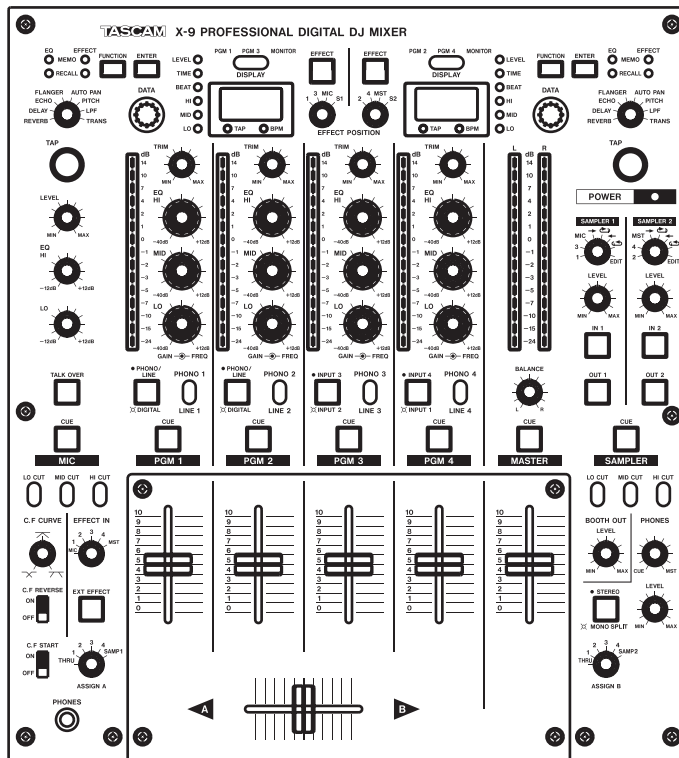

OWNER'S MANUAL



CAUTION
RISK OF ELECTRIC SHOCK
DO NOT OPEN

CAUTION: TO REDUCE THE RISK OF ELECTRIC SHOCK, DO NOT REMOVE COVER (OR BACK). NO USER-SERVICEABLE PARTS INSIDE. REFER SERVICING TO QUALIFIED SERVICE PERSONNEL.



The lightning flash with arrowhead symbol, within an equilateral triangle, is intended to alert the user to the presence of uninsulated "dangerous voltage" within the product's enclosure that may be of sufficient magnitude to constitute a risk of electric shock to persons.



The exclamation point within an equilateral triangle is intended to alert the user to the presence of important operating and maintenance (servicing) instructions in the literature accompanying the appliance.

This appliance has a serial number located on the bottom. Please record the model number and serial number and retain them for your records.
Model number _____
Serial number _____

WARNING: TO PREVENT FIRE OR SHOCK HAZARD, DO NOT EXPOSE THIS APPLIANCE TO RAIN OR MOISTURE.

Important Safety Precautions

IMPORTANT (for U.K. Customers)

DO NOT cut off the mains plug from this equipment.

If the plug fitted is not suitable for the power points in your home or the cable is too short to reach a power point, then obtain an appropriate safety approved extension lead or consult your dealer.

If nonetheless the mains plug is cut off, remove the fuse and dispose of the plug immediately, to avoid a possible shock hazard by inadvertent connection to the mains supply.

If this product is not provided with a mains plug, or one has to be fitted, then follow the instructions given below:

IMPORTANT: DO NOT make any connection to the larger terminal which is marked by the letter E or by the safety earth symbol \perp or coloured GREEN or GREEN-and-YELLOW.

The wires in this mains lead are coloured in accordance with the following code:

BLUE	: NEUTRAL
BROWN	: LIVE

As the colours of the wires in the mains lead of this apparatus may not correspond with the coloured markings identifying the terminals in your plug proceed as follows:

The wire which is coloured BLUE must be connected to the terminal which is marked with the letter N or coloured BLACK.

The wire which is coloured BROWN must be connected to the terminal which is marked with the letter L or coloured RED.

When replacing the fuse only a correctly rated approved type should be used and be sure to re-fit the fuse cover.

IF IN DOUBT — CONSULT A COMPETENT ELECTRICIAN.

For U.S.A

TO THE USER

This equipment has been tested and found to comply with the limits for a Class A digital device, pursuant to Part 15 of the FCC Rules. These limits are designed to provide reasonable protection against harmful interference when the equipment is operated in a commercial environment. This equipment generates, uses, and can radiate radio frequency energy and, if not installed and used in accordance with the instruction manual, may cause harmful interference to radio communications.

Operation of this equipment in a residential area is likely to cause harmful interference in which case the user will be required to correct the interference at his own expense.

CAUTION

Changes or modifications to this equipment not expressly approved by TEAC CORPORATION for compliance could void the user's authority to operate this equipment.

For the consumers in Europe

WARNING

This is a Class A product. In a domestic environment, this product may cause radio interference in which case the user may be required to take adequate measures.

Pour les utilisateurs en Europe

AVERTISSEMENT

Il s'agit d'un produit de Classe A. Dans un environnement domestique, cet appareil peut provoquer des interférences radio, dans ce cas l'utilisateur peut être amené à prendre des mesures appropriées.

Für Kunden in Europa

Warnung

Dies is eine Einrichtung, welche die Funk-Entstörung nach Klasse A besitzt. Diese Einrichtung kann im Wohnbereich Funkstörungen verursachen ; in diesem Fall kann vom Betreiber verlang werden, angemessene Maßnahmen durchzuführen und dafür aufzukommen.

The equipment draws nominal non-operating power from the AC outlet with its POWER switch in the off position.

IMPORTANT SAFETY INSTRUCTIONS

CAUTION:

- Read all of these Instructions.
- Save these Instructions for later use.
- Follow all Warnings and Instructions marked on the audio equipment.

- 1) Read Instructions** — All the safety and operating instructions should be read before the product is operated.
- 2) Retain Instructions** — The safety and operating instructions should be retained for future reference.
- 3) Heed Warnings** — All warnings on the product and in the operating instructions should be adhered to.
- 4) Follow Instructions** — All operating and use instructions should be followed.
- 5) Cleaning** — Unplug this product from the wall outlet before cleaning. Do not use liquid cleaners or aerosol cleaners. Use a damp cloth for cleaning.
- 6) Attachments** — Do not use attachments not recommended by the product manufacturer as they may cause hazards.
- 7) Water and Moisture** — Do not use this product near water — for example, near a bath tub, wash bowl, kitchen sink, or laundry tub; in a wet basement; or near a swimming pool; and the like.
- 8) Accessories** — Do not place this product on an unstable cart, stand, tripod, bracket, or table. The product may fall, causing serious injury to a child or adult, and serious damage to the product. Use only with a cart, stand, tripod, bracket, or table recommended by the manufacturer, or sold with the product. Any mounting of the product should follow the manufacturer's instructions, and should use a mounting accessory recommended by the manufacturer.
- 9)** A product and cart combination should be moved with care. Quick stops, excessive force, and uneven surfaces may cause the product and cart combination to overturn.



- 10) Ventilation** — Slots and openings in the cabinet are provided for ventilation and to ensure reliable operation of the product and to protect it from overheating, and these openings must not be blocked or covered. The openings should never be blocked by placing the product on a bed, sofa, rug, or other similar surface. This product should not be placed in a built-in installation such as a bookcase or rack unless proper ventilation is provided or the manufacturer's instructions have been adhered to.
- 11) Power Sources** — This product should be operated only from the type of power source indicated on the marking label. If you are not sure of the type of power supply to your home, consult your product dealer or local power company. For products intended to operate from battery power, or other sources, refer to the operating instructions.
- 12) Grounding or Polarization** — This product may be equipped with a polarized alternating-current line plug (a plug having one blade wider than the other). This plug will fit into the power outlet only one way. This is a safety feature. If you are unable to insert the plug fully into the outlet, try reversing the plug. If the plug should still fail to fit, contact your electrician to replace your obsolete outlet. Do not defeat the safety purpose of the polarized plug.
- 13) Power-Cord Protection** — Power-supply cords should be routed so that they are not likely to be walked on or pinched by items placed upon or against them, paying particular attention to cords at plugs, convenience receptacles, and the point where they exit from the product.
- 14) Outdoor Antenna Grounding** — If an outside antenna or cable system is connected to the product, be sure the antenna or cable system is grounded so as to provide some protection against voltage surges and built-up static charges. Article 810 of the National Electrical Code, ANSI/NFPA 70, provides information with regard to proper grounding of the mast and supporting structure, grounding of the lead-in wire to an antenna discharge unit, size of grounding conductors, location of antenna-discharge unit, connection to grounding electrodes, and requirements for the grounding electrode.

"Note to CATV system installer:

This reminder is provided to call the CATV system installer's attention to Section 820-40 of the NEC which provides guidelines for proper grounding and, in particular, specifies that the cable ground shall be connected to the grounding system of the building, as close to the point of cable entry as practical.

Example of Antenna Grounding as per National Electrical Code, ANSI/NFPA 70

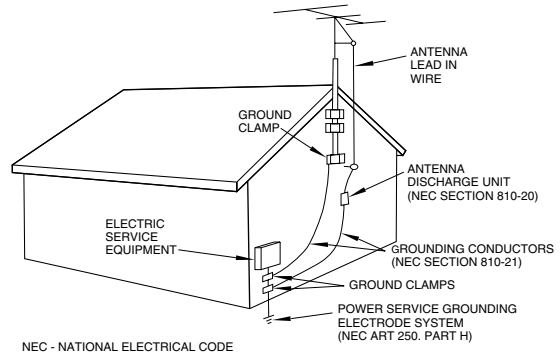

- 15) Lightning** — For added protection for this product during a lightning storm, or when it is left unattended and unused for long periods of time, unplug it from the wall outlet and disconnect the antenna or cable system. This will prevent damage to the product due to lightning and power-line surges.
- 16) Power Lines** — An outside antenna system should not be located in the vicinity of overhead power lines or other electric light or power circuits, or where it can fall into such power lines or circuits. When installing an outside antenna system, extreme care should be taken to keep from touching such power lines or circuits as contact with them might be fatal.
- 17) Overloading** — Do not overload wall outlets, extension cords, or integral convenience receptacles as this can result in risk of fire or electric shock.
- 18) Object and Liquid Entry** — Never push objects of any kind into this product through openings as they may touch dangerous voltage points or short-out parts that could result in a fire or electric shock. Never spill liquid of any kind on the product.
- 19) Servicing** — Do not attempt to service this product yourself as opening or removing covers may expose you to dangerous voltage or other hazards. Refer all servicing to qualified service personnel.
- 20) Damage Requiring Service** — Unplug this product from the wall outlet and refer servicing to qualified service personnel under the following conditions:
 - a) when the power-supply cord or plug is damaged.
 - b) if liquid has been spilled, or objects have fallen into the product.
 - c) if the product has been exposed to rain or water.
 - d) if the product does not operate normally by following the operating instructions. Adjust only those controls that are covered by the operating instructions as an improper adjustment of other controls may result in damage and will often require extensive work by a qualified technician to restore the product to its normal operation.
 - e) if the product has been dropped or damaged in any way.
 - f) when the product exhibits a distinct change in performance — this indicates a need for service.
- 21) Replacement Parts** — When replacement parts are required, be sure the service technician has used replacement parts specified by the manufacturer or have the same characteristics as the original part. Unauthorized substitutions may result in fire, electric shock, or other hazards.
- 22) Safety Check** — Upon completion of any service or repairs to this product, ask the service technician to perform safety checks to determine that the product is in proper operating condition.
- 23) Wall or Ceiling Mounting** — The product should be mounted to a wall or ceiling only as recommended by the manufacturer.
- 24) Heat** — The product should be situated away from heat sources such as radiators, heat registers, stoves, or other products (including amplifiers) that produce heat.

Table of Contents

1 – Introduction	
Some notes and precautions	5
Environmental considerations	5
Connections to other equipment	5
Serial number, etc.	5
2 – Getting acquainted with the X-9	
Road map to front panel functions	6
Program gain level, EQ and assignment section ..	6
Sampler section	7
Microphone control	7
Cue selection keys and monitor keys	7
Master fader	8
Program faders	8
External effect	8
Cross-fader and fader controls	9
Effect, menu, etc. management	9
3 – Connections	
Record turntables	10
CD decks, etc.	10
Digital connections	10
Amplifier system	10
Booth outputs	11
Microphone (connection and use)	11
External effects unit	12
Headphones (connecting and using)	12
Fader start/stop connections	12
Footswitches	12
External effects	13
4 – Learning more	
About programs	14
Assigning sources to programs	14
Trim	14
Cross-fading	14
Signal flow	15
Playing a song	16
Adjusting the output volume	16
Cue (previewing sounds)	16
5 – Menus	
How the X-9 shows characters	17
Menu reference	17
6 – Faders	
Program fader “curve”	21
Program fader direction	21
Fader start	21
Cross-fader curve	22
Cross-fader start	22
Cross-fader reverse	22
7 – Effects	
Selecting the effect type	23
Editing the effects	23
The BEAT parameter	23
Effect parameters	24
Storing effects	24
Recalling stored effect settings	25
8 – Samplers	
Recording a sample	26
Playing back samples	26
Editing samples	27
Erasing samples	27
Sample pitch	27
9 – EQ	
EQ Q setting	28
Cutting the EQ bands	28
Viewing EQ settings	28
Remembering and recalling EQ settings	29
10 – Specifications, etc.	
I/O specifications	30
Audio I/O	30
Control I/O	30
Audio specifications	31
General specifications	31
Dimensional drawing	32
Mounting the X-9 in a rack	33
Case mounting	33
Block diagram	34

1 – Introduction

The X-9 is a sophisticated DJ mixer which allows the connection of many devices, and allows you to mix in a creative way, adding effects, taking samples, etc. and crossfading between sources.

Following the standard design pattern for such a device, the X-9 combines easy operation with a wide range of functions.

Smooth faders, easy-to-use controls and clear indicators displays allow you to concentrate on the music, not the operation of the unit.

Some notes and precautions

Treat the X-9 as you would any other piece of precision equipment.

Avoid exposing it to extremes of temperature and humidity and avoid mechanical shocks and vibration.

Keep the unit away from strong magnetic fields (TV sets, computer monitors, large electric motors, etc.).

Environmental considerations

The X-9 may be used in most areas, but to maintain top performance, and prolong operating life, observe the following environmental conditions:

The nominal temperature should be between 5°C and 35°C (41°F and 95°F).

Relative humidity should be 30 to 90 degrees non-condensing.

As the unit may become hot during operation, always leave sufficient space above and around the unit for ventilation. If you are mounting the unit in a rack, leave 1U of space above it.

Do not install this equipment in a confined space such as a bookcase or similar unit.

You should not place the unit on a piece of equipment generating heat, e.g. an amplifier, to avoid possible problems with overheating.

The voltage supplied to the unit should match the voltage as printed on the rear panel. If you are in any doubt regarding this matter, consult an electrician.

NOTE

When transporting the unit, always use the original packing materials or a properly-designed equipment case. For this reason, we strongly recommend that you save all the packing materials that came with the X-9, in case you need to transport it in the future.

Connections to other equipment

It is extremely important that the power is turned off on all units when making or breaking connections to or from the X-9.

When turning power on, it is usually a good idea to start with the source (turntables, CD players, etc.), then the X-9 and finish with the amplifier system.

Turning power off should be done in the other direction (amplifiers first, then other equipment).

Serial number, etc.

The serial number of the X-9 is located on a sticker at the front of the unit on the bottom panel. Make a note

of this for future reference (warranty, etc.).

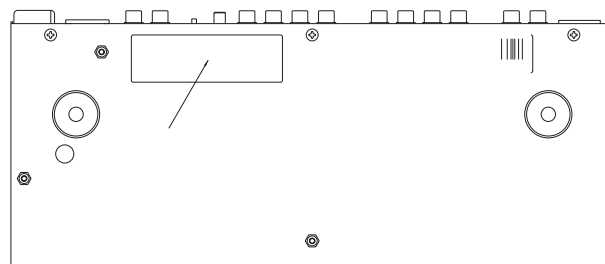

2 – Getting acquainted with the X-9

Road map to front panel functions

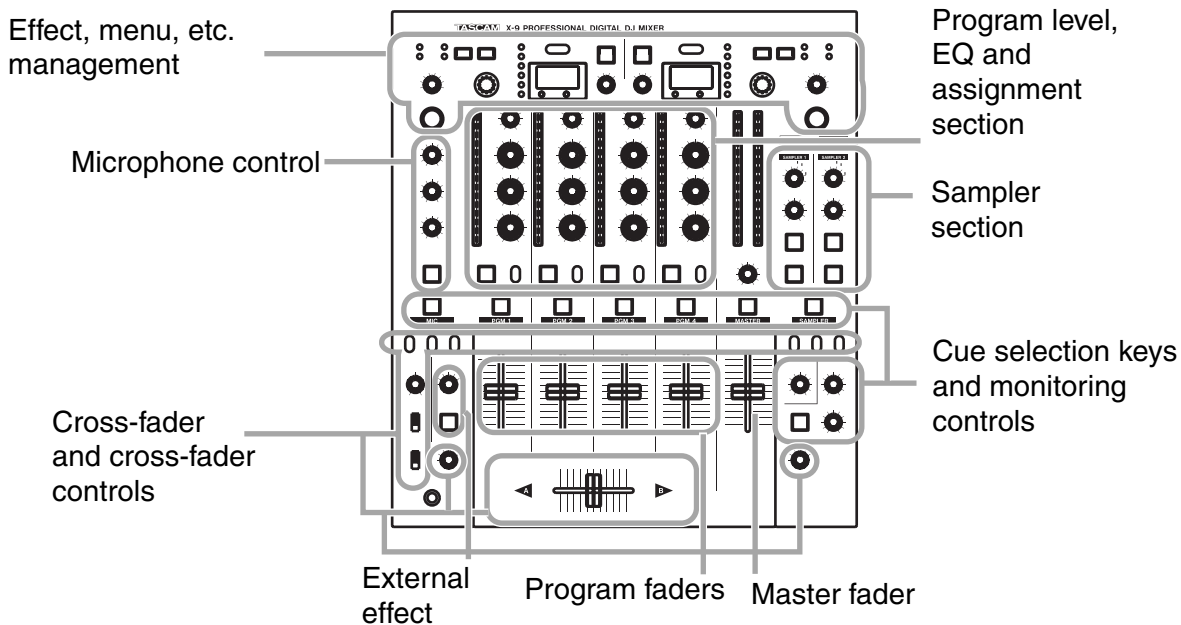

These different sections of the X-9 are described more fully in other parts of the manual, but this section gives you a quick orientation to help you find your way around the mixer.

See “Connections” on page 10 for details of the rear panel features and how to make connections between the X-9 and other equipment.

Program gain level, EQ and assignment section

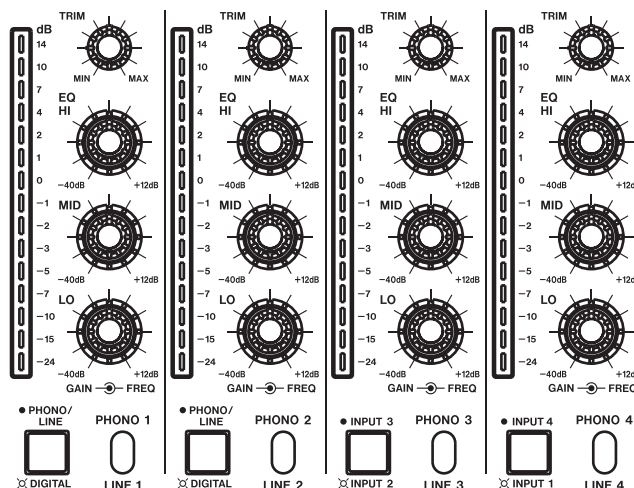

This section provides the basic mixing facilities to control the sound received at the inputs, and assigned to the programs.

See “About programs” on page 14 for details of how inputs and programs work together and how to use these controls.

Sampler section

The sampler section provides the controls for two built-in samplers.

These are capable of accepting the input from a variety of sources (program, microphone or master mix), and recording eight seconds of sound (for each sampler).

You can then play the resulting sample from the X-9, cue it, etc. and add it to the overall mix.

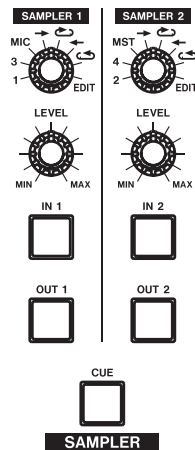

Samplers can be assigned to the cross-fader signals, and the cross-fader can be used to start them.

See “Samplers” on page 26 for full details of how to operate these samplers.

Microphone control

This section provides control over the microphone.

A talkover function, as well as 2-band EQ, is provided in this section for use with the microphone.

See “Microphone (connection and use)” on page 11 for full details of how to use the microphone with the X-9.

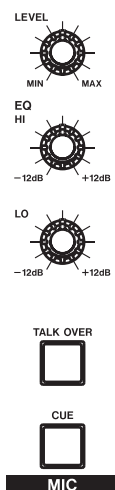

Cue selection keys and monitor keys

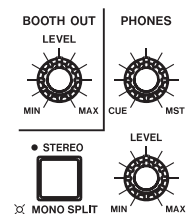
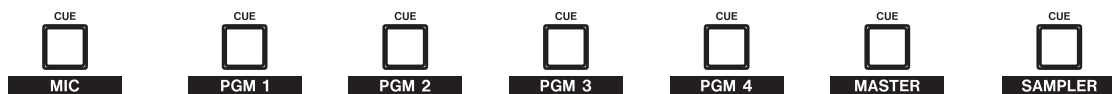

These keys allow the selection of the programs, microphone, sampler, etc. for cueing and preview.

The headphones are used for this purpose, and the booth outputs may be used to provide a second set of stereo outputs.

See “Headphones (connecting and using)” on page 12 and “Cue (previewing sounds)” on page 16 for details.

2 Getting acquainted with the X-9

Master fader

The master fader is used to control the overall level of the mixed signal output from the X-9.

See “Signal flow” on page 15 for details of how this works in conjunction with the input, etc., signals in the X-9.

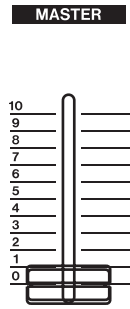

Program faders

These faders adjust the levels of the programs after they have been equalized and before they are sent to either the cross-fader or to the master fader.

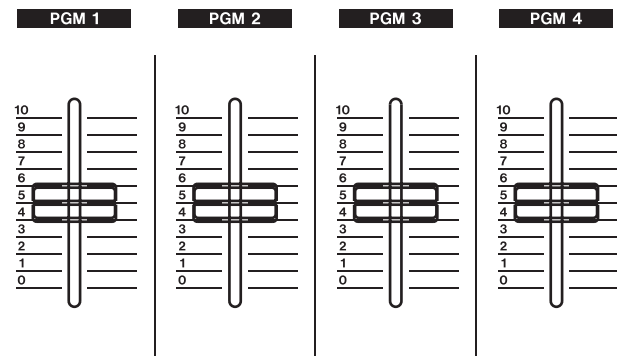

The fader curve and fader direction can also be set, and fader program start can be carried out.

See “About programs” on page 14 for details of how programs and signals interact.

See “Faders” on page 21 for further details about fader settings.

External effect

These controls affect the assignment and the on/off status of any external effect connected to the X-9.



See “External effects” on page 13 for details of how to connect and use an external effect processor with the X-9.

Cross-fader and fader controls

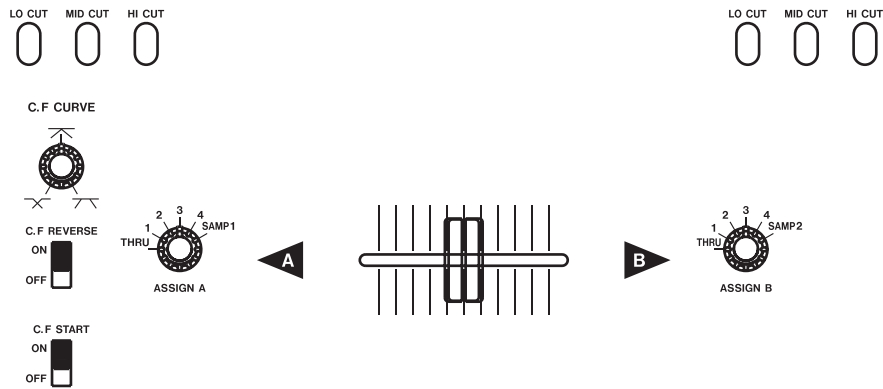

These take care of the A and B outputs which are assigned to the cross-fader using the **ASSIGN** controls, and then passed to the master stereo output. It is possible to set the cross-fader curve, reversal, and allow source starting with the cross-fader.

See “Cross-fading” on page 14 for details of how the cross-fader fits into the signal chain.

See “Faders” on page 21 for details of cross-fader settings.

Effect, menu, etc. management

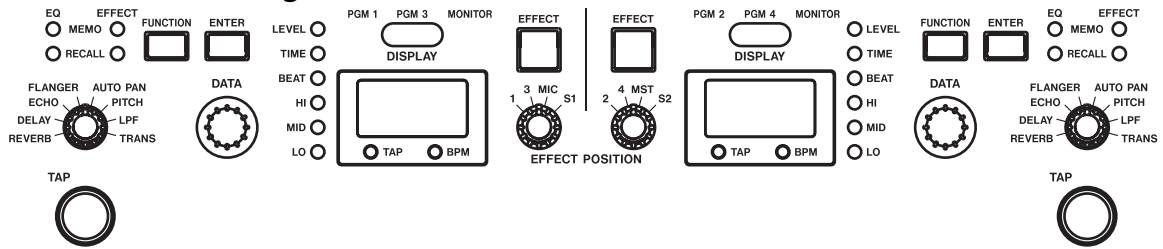

This section handles the effects, the parameter menus and the equalization memories of the X-9.

See “EQ” on page 28, “Effects” on page 23 and “Menu reference” on page 17 for details.

3 – Connections

This section gives a brief description of the connections you should make before starting to use the X-9.

WARNING

Make and break all connections between the X-9 and other equipment with everything turned **OFF**. If you make or break connections with the power turned on,

there is a very real risk of damaging the equipment, including the X-9.

NOTE

All XLR connectors on the X-9 are wired so that pin 1=ground, pin 2= hot and pin 3=cold. Make sure that all equipment connected using these connectors also conforms to this wiring standard.

Record turntables

Only connect record turntables to the **PHONO** connectors (1, 2, 3 or 4).

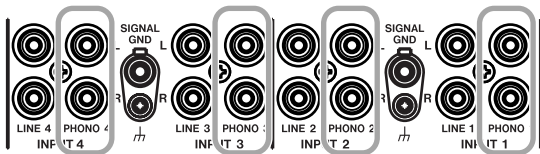

WARNING

Never connect record turntables to any other type of connector on the X-9.

Never connect any other type of equipment to the **PHONO** connectors.

If the turntables are fitted with grounding wires, connect these to the ground terminals on the X-9.

NOTE

Note that the X-9 is supplied with eight RCA caps which should be fitted over the PHONO terminals if they are not being used. This will help to maintain high signal quality.

TIP

The X-9 pairs of connectors all have the left connector at the top and the right at the bottom. Pairs of pin signal cables are typically red for the right channel and some other color for the left channel.

We explain about connecting other equipment (CD decks, etc.) including digital connections, below.

CD decks, etc.

Connect CD decks to the **LINE** connectors (1 through 4) on the rear panel. Unlike record decks, CD decks do not need to be grounded to the X-9).

WARNING

CD decks, etc. should never be attached to the **PHONO** connections.

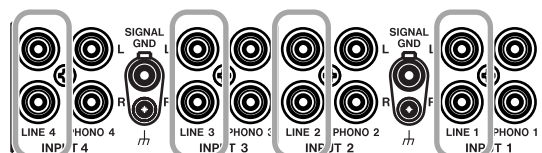

Digital connections

The X-9 can be connected to devices which output SPDIF digital audio through a coaxial output (many CD players, MD players and DATs, as well as some electronic musical instruments) and can also output a digital audio version of the final mix (to a digital recorder such as a DAT, or a CD recorder, or a suitably-equipped personal computer).

Use menu item *14dL* to set whether the signal is output pre- or post- master fader (“Menu reference” on page 17).

Use RCA pin jack cables to make connections between the digital outputs of other equipment and the **DIGITAL IN** connectors of the X-9, and digital inputs of other equipment and the **DIGITAL OUT** of the X-9.



Amplifier system

To listen to the X-9, you will need an amplifier and speaker system, which is connected as explained here.

When connecting an amplification system to the X-9, check the inputs of the amplifier. If they look like either of the connectors shown here, they are XLR connectors and are probably balanced.

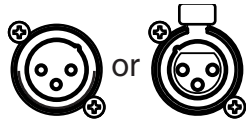

Check the rear panel of the amplifier, or the amplifier's manual, to make sure. Amplifiers with balanced inputs should be fed by the **MASTER OUTPUT (BALANCED)** output connectors of the X-9.

All other connectors (mono 1/4" jack or RCA pin jacks) should be fed by the **(UNBALANCED)** RCA pin outputs.

The level of the output from the unbalanced outputs can be set using the **PRE/POST** switch to be affected by the master fader (**POST**) or unaffected by it (**PRE**).

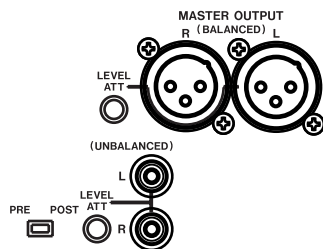

WARNING

It is most important to make sure that you make the correct connections. Connecting the wrong output of the X-9 to the amplification system can result in overheating and possible damage to both the X-9 and to the amplification system.

If you are in any doubt at all, we strongly suggest that you consult your TASCAM dealer or other qualified audio professional regarding the interconnection of your system.

Use the trimmer potentiometers (**LEVEL ATT**) to adjust the output level to the amplification systems. Again, you may find it useful to consult the amplification system documentation and/or consult a professional sound engineer.

Booth outputs

The booth outputs provide you with a second mix where the level is not controlled by the master fader, but by the **BOOTH LEVEL** volume control.



Connect the unbalanced **BOOTH OUTPUT** RCA jacks to the unbalanced inputs of the booth amplification system.



Microphone (connection and use)

To input your voice through the X-9 system, you need to connect a microphone to the system. The X-9 provides an XLR connector for connecting a standard (dynamic) microphone.



Connect your favorite microphone to this connector.

Use the **TALK OVER** key to "dim" all the signals except the microphone by 20 dB (the key lights when active).

Adjust the level of the microphone signal sent to the master fader with the **LEVEL** control.

Adjust the tone of the microphone signal with the **HI** (treble) and **LO** (bass) **EQ** controls.

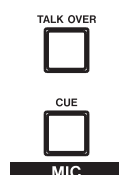
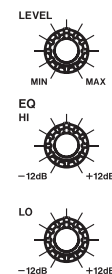

Use the menu system (*1Bbñ*) to change the left-right balance of the microphone signal.

You can also select the microphone signal to be passed through the internal or external effects, as well as being used as a source for sampler 1.

The microphone signal can be cued (see "Cue (pre-viewing sounds)" on page 16) in the same way as program signals, using the **CUE** key (lights when active).

3 Connections

External effects unit

Use the **SEND** and **RETURN** 1/4" jacks to connect any external effects unit. For full

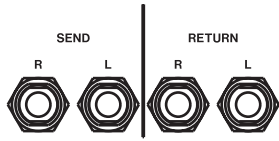

details of connection and use of an external unit, see “External effects” on page 13

Headphones (connecting and using)

Connect a standard pair of stereo headphones to the stereo 1/4" jack on the top or at the front of the X-9. These two jacks output the same signals and are controlled by the same controls.

Use the headphone **PHONES LEVEL** control to adjust the volume of the signal from the headphones.

There are four EQ settings, which can be made using the menu system (menu \square *IHP*)—see “Menu reference” on page 17. These settings boost either the low or the high part of the frequency range, or both. The fourth setting is a “normal” setting—no cut or boost.

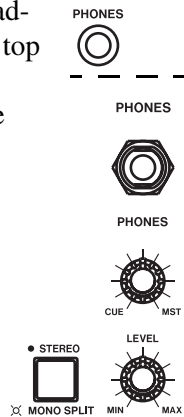

The balance between the cue mix (see “Cue (pre-viewing sounds)” on page 16) and the master cue mix in the headphones is set using the upper **PHONES** control. Turn counterclockwise for cue signals (**CUE**) and clockwise for main master cue mix (**MST**).

In addition, the headphone output can be in stereo outputs or set so that the left headphone outputs the cue signal (in mono, of course) and the right headphone outputs the master main signal (in mono).

Use the **STEREO** (the indicator is unlit)/**MONO SPLIT** (indicator is lit) key to change between these two modes.

In the **MONO SPLIT** mode, the cue signal is output from the left headphone, and the master cue signal from the right headphone. Use the **CUE/MST** control to adjust the relative levels.

Fader start/stop connections

The four mono mini-jacks (3.5 mm) are connected so that the tip feeds a fader start, and the sleeve feeds a fader stop.

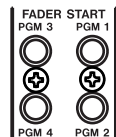

The ground for these connections is provided by the signal ground of the device to which the fader start is made.

NOTE

Even if the device is connected digitally to the X-9 (such as a CD or MD player) for the audio connection, an ana-

log connection must also be made to provide the ground for the fader start.

Note that the fader start control refers to the program number—see “About programs” on page 14 (not the device number).

To activate fader start/stop for individual programs, follow the instructions in “Fader start” on page 21.

To activate fader start/stop for the devices assigned to the cross-fader signals, follow the instructions in “Cross-fader start” on page 22.

Footswitches

You can connect one or two (optional) footswitches, such as the TASCAM RC-30P model, to the X-9's **FOOT SW** jacks.

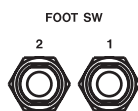

These footswitches can be used for a variety of purposes, such as sampler control, effect on and off, etc. Use the menu item (*BBFL*) (“Menu reference” on page 17) for full details of how these switches can be set up.

External effects

The X-9 can send signals to and accept return signals from an external effects unit.

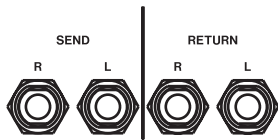

Such a unit can be connected using the **SEND** (to the effects unit) and **RETURN** (from the effects unit) jacks.

If the effects unit is only capable of accepting a mono input, read the documentation supplied with the effects unit, and make the appropriate connection to the **L** effect **SEND** jack of the X-9.

If the effects unit is only capable of producing a mono output, read the documentation supplied with the effects unit, and make the appropriate connection to the **L** **RETURN** jack of the X-9.

NOTE

The return from the external input cannot be output from the digital output.

To use the external effects unit

Turn the **EFFECT IN** knob to select the signal that will be processed by the effects unit: a program (**1** through **4**), the microphone signal (**MIC**) or the master mix (**MST**).

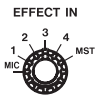

Adjust the input level to the effects unit and the output level of the signal from the effects unit using the controls of the external unit.

Turn the effect loop on and off with the **EXT EFFECT** key (it lights when the loop is active).

It is also possible to use an external effects unit through the footswitches (see “Footswitch assignment” on page 18 for details of this menu setting (**08Ft0**)).

TIP

For a strange effect, you can send and return the left channel of a program through one effects unit, and the right channel of the same program through another effects unit with different settings.

4 – Learning more

The X-9 has four sets of inputs, as well as the two built-in samplers and the microphone input, all of which can be mixed and used as sound sources.

There are a number of different signals that can be fed into the X-9: up to four turntables, and four other

analog devices, and two digital devices, not to mention the two internal samplers and the microphone.

In order to understand the X-9, it is necessary to get a basic idea of where the signals go.

About programs

These inputs are assigned to four mixer channels (modules), known as *programs*, and numbered from 1 through 4. The levels of the programs are controlled using program faders.

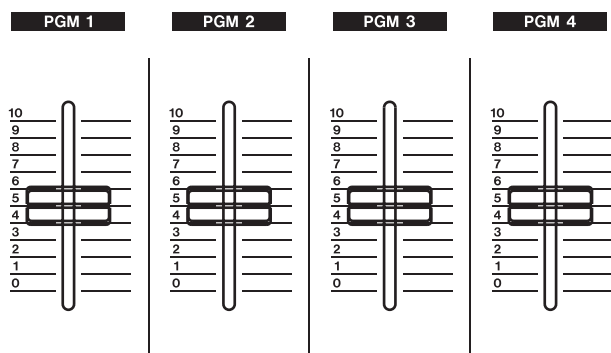

In addition, each program is equipped with 3-band sweepable EQ, with variable Q, and a trim control.

The left-right balance of each program is adjusted using the menu system with *19b1*, *20b2*, *21b3* and *22b4* (see “Menu reference” on page 17).

Assigning sources to programs

Use the switches on the top panel to change between the **LINE** and **PHONO** inputs.

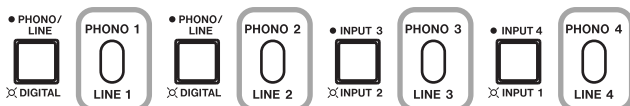

In addition, there is a key beside each of these switches, allowing you to choose different sources for the programs:

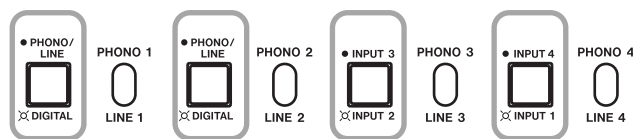

The keys for programs 1 and 2 allow the digital inputs to be selected as an alternative to the **PHONO/LINE** pair. When the indicators for these keys are lit (the digital is selected), the **PHONO/LINE** switch has no effect.

The keys for programs 3 and 4 allow input 2 to be selected for program 3 and/or input 1 to be selected for program 4. The meaning of inputs 1 and 2 is decided by the **PHONO/LINE** switches for 1 and 2 and by the digital selection keys.

Trim

When the inputs have been assigned, adjust the level fed to the equalizer, and then the fader, using the program's **TRIM** control.



This provides 38 dB of adjustment. Note that turning this control too far clockwise with a powerful input signal may result in a distorted signal.

Cross-fading

When the two program sources have been assigned as shown above (“About programs” on page 14), they

can be transferred to the outputs through the cross-fader and then through the master fader.

The two signals that are controlled by the cross-fader are known as **A** and **B**.

You can set these to be any of the following using the **ASSIGN A** and **ASSIGN B** controls below and to the right and left of the program faders:

Programs 1 through 4, a sampler (**SAMP 1** for A, and **SAMP 2** for B) or **THRU**.

The **THRU** setting is equivalent to OFF. In other words, if either

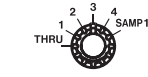

Note that this is **SAMP1** for the **ASSIGN A** control

the **ASSIGN A** or the **ASSIGN B** control is set to **THRU**, no signal is assigned to go through the cross-fader on that side, and moving the cross-fader to the side with the **THRU** setting has no effect on that side. When **THRU** is selected, use the appropriate program fader(s) and the master fader.

Move the fader from the left (fully A signal only) to the right (fully B signal only) to perform the cross-fade between the two signals.

Signal flow

The signal flow is therefore:

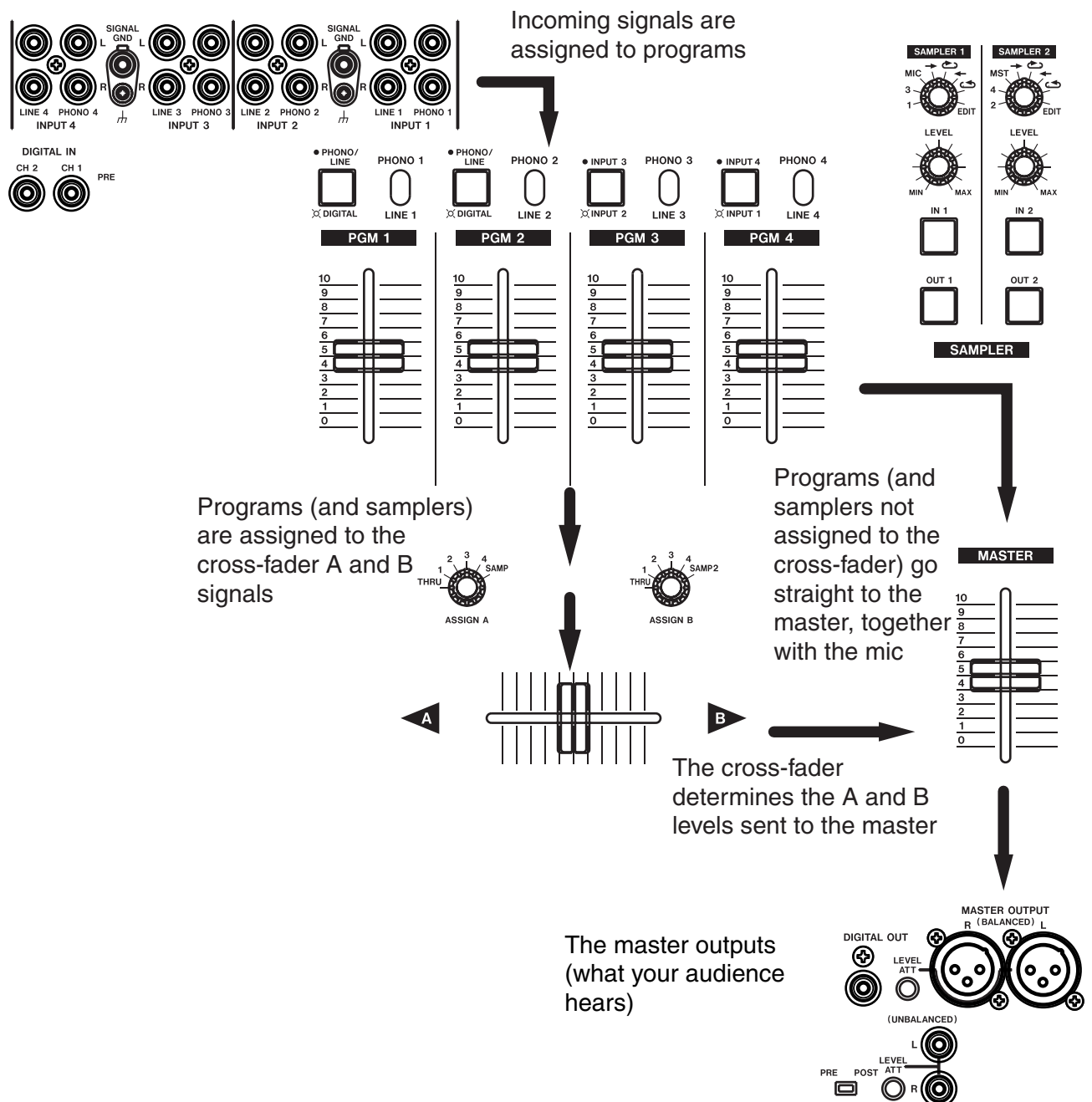

4 Learning more

Playing a song

When you have made connections as described in “Connections” on page 10, you can start playing a song.

With the program fader at its lowest level (0) and the master fader also at 0, load a CD in the player, or put a record on the turntable connected in the earlier step

(“Record turntables” on page 10 and “CD decks, etc.” on page 10).

Cue up the CD or record using the cue functions as described below (use headphones to monitor the CUE output while the **CUE** indicator for the program with the record is lit).

Adjusting the output volume

Set the amplifier volume to less than full setting.

Bring the **MASTER** fader up to about the **7** mark, and slowly bring adjust the program fader until the overall level is what you want.

Use the program meter to view the level of the program signal, and the stereo **MASTER** meters to check the overall level of the signal fed from the X-9 outputs.

If the top segment of a meter (**14 dB**) is lit for most of the time, the sound coming out of the X-9 will be

distorted. You should therefore try to keep the level so that the red segments of the meters are not lit all the time.

You can set the time that the meters take to fall back, as well as the time that they hold peak values, using the *12nr* and *13nP* menus (see “Meter release time” on page 19 and “Meter peak hold time” on page 19).

TIP

We suggest this way of working to avoid possible overloading of the internal amplifiers, and distortion caused by such overloading.

Cue (previewing sounds)

The X-9’s cue system allows you to preview a program through headphones before playing it back through the main amplifier system.

Use the controls as described in “Headphones (connecting and using)” on page 12 to select the cue output to the headphones.

Press any of the program **CUE** keys, the microphone **CUE** key,

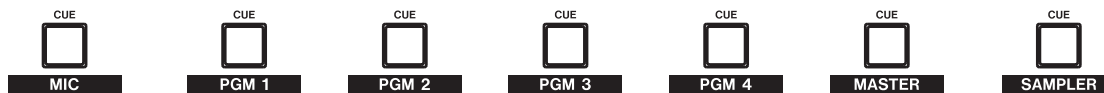
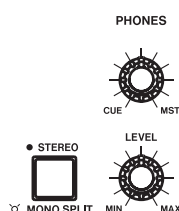

The programs and samplers, are monitored done pre-fader (that is, moving the program fader or adjusting the sampler **LEVEL** controls has no effect on the monitor signal level). On the other hand, the master cue output is monitored post-fader (moving the master fader affects the monitoring volume).

the sampler **CUE** key or the **MASTER** cue key to listen to the cue signal for that source.

When one of these keys is active (that is, the source is routed through the cue mix to the headphones), the key is lit.

Remember that no monitoring of the cue signals is possible if none of the **CUE** keys is lit.

The microphone is monitored after the **LEVEL** control.

Use the **CUE/MST** headphone control to adjust the balance between the cue and master signals in the headphones.

The X-9 uses a menu system to allow various functions to be enabled.

You should read through the menu section (“Menu reference” on page 17) to find out exactly what is possible—the X-9 may possibly do more than you first thought, thanks to the menu system.

To use the menus:

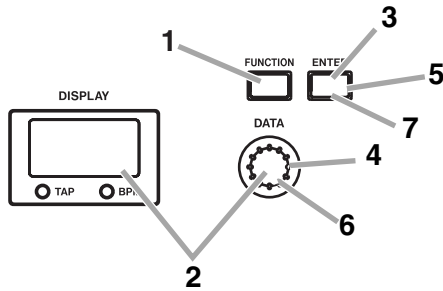

- 1 Press the **FUNCTION** key.
- 2 Turn the **DATA** knob to select the menu description (a 4-character code shown on the display).

- 3 Press **ENTER** to confirm that you want to use this menu.
- 4 Turn the **DATA** knob to change the value for the menu.
- 5 Some menus have only one setting. For these menus, press **ENTER** to confirm the setting and leave the menu system.

For menus with two settings (for example, first selecting the sampler whose settings will be changed and then changing the setting), press **ENTER** to confirm the first setting.

- 6 Turn the **DATA** knob to set the next value.
- 7 Press **ENTER** to confirm the setting and leave the menu system.

Typically, most menus can be performed using either the right and left menu systems (consisting of keys, dial and display).

The menus and the different settings you can make are listed in “Menu reference” on page 17.

These menu controls are also used with the effects units, as explained here (“Effects” on page 23).

How the X-9 shows characters

It’s usually fairly clear what’s being shown on the X-9 display. However, you may want to refer to this

chart if you are not quite sure how things are being shown:

A	B	C	D	E	F	G	H	I	J	K	L	M	N	O	P	Q	R	S	T	U	V	W	X	Y	Z
<i>A</i>	<i>b</i>	<i>c</i>	<i>d</i>	<i>E</i>	<i>F</i>	<i>G</i>	<i>H</i>	<i>I</i>	<i>J</i>	<i>K</i>	<i>L</i>	<i>M</i>	<i>N</i>	<i>O</i>	<i>P</i>	<i>Q</i>	<i>R</i>	<i>S</i>	<i>T</i>	<i>U</i>	<i>V</i>	<i>W</i>	<i>X</i>	<i>Y</i>	<i>Z</i>
0	1	2	3	4	5	6	7	8	9	-	_	+													
<i>0</i>	<i>1</i>	<i>2</i>	<i>3</i>	<i>4</i>	<i>5</i>	<i>6</i>	<i>7</i>	<i>8</i>	<i>9</i>	<i>-</i>	<i>_</i>	<i>=</i>													

Menu reference

The following table provides a list of the menu options available on the X-9, together with the parameters available and their meaning.

In this table, default (factory) settings are marked with a *.

See “Menus” on page 17 for details of how to use the menu system.

5 Menus

Function	Menu display	Meaning	Available settings	Notes
Headphone EQ	<i>01HP</i>	Sets headphone EQ to normal, high or low boost	<i>n0r</i> * (no EQ) <i>H</i> High boost <i>L</i> Low boost <i>HL</i> High and low boost	Can be performed on both left and right menu systems. Takes immediate effect before being confirmed.
Program 1 fader start	<i>02F1</i>	Sets fader start for program 1 on or off	<i>0FF</i> * Fader start disabled <i>0n</i> Fader start enabled	Can be performed on both left and right menu systems.
Program 2 fader start	<i>03F2</i>	Sets fader start for program 2 on or off	<i>0FF</i> * Fader start disabled <i>0n</i> Fader start enabled	Can be performed on both left and right menu systems.
Program 3 fader start	<i>04F3</i>	Sets fader start for program 3 on or off	<i>0FF</i> * Fader start disabled <i>0n</i> Fader start enabled	Can be performed on both left and right menu systems.
Program 4 fader start	<i>05F4</i>	Sets fader start for program 4 on or off	<i>0FF</i> * Fader start disabled <i>0n</i> Fader start enabled	Can be performed on both left and right menu systems.
Cross-fader A start	<i>6cFA</i>	Sets the cross-fader to start signal A playback	<i>0FF</i> Fader start disabled <i>0n</i> * Cross-fader starts signal A playback	Can be performed on both left and right menu systems.
Cross-fader B start	<i>7cFb</i>	Sets the cross-fader to start signal B playback	<i>0FF</i> Fader start disabled <i>0n</i> * Cross-fader starts signal B playback	Can be performed on both left and right menu systems.
Footswitch assignment	<i>08Ft</i>	Sets the function of the footswitches connected to the X-9.	<i>EF</i> * links to internal effects (1=effect 1, 2=effect 2) <i>E</i> links to external effects (1& 2=external) <i>S1</i> Sampler 1 (1=in, 2=out) <i>S2</i> Sampler 2 (1=in, 2=out) <i>cF</i> Crossfader (<i>1</i> on, hard A side, <i>1</i> off, current position; <i>2</i> on, hard B side, <i>2</i> off, current position)	Can be performed on both left and right menu systems.
EQ memory store	<i>09En</i>	Stores currently-selected EQ settings to memory.	Use the left menu system for programs 1 and 3. Use the right menu system for programs 2 and 4. The EQ MEMO indicator lights when <i>09En</i> is selected When ENTER is first pressed, the lowest empty memory bank number is shown. Use the dial to select a bank. If the bank already contains a setting, the display shows <i>SURE</i> . Press ENTER to overwrite, or any other key to cancel.	
EQ memory recall	<i>10Er</i>	Recalls stored EQ memory settings to current program.	Use the left menu system for programs 1 and 3. Use the right menu system for programs 2 and 4. The EQ RECALL indicator lights when <i>10Er</i> is selected Use the dial to select a bank containing EQ memory (only banks containing data are shown). Press ENTER to recall the memory.	

Function	Menu display	Meaning	Available settings	Notes
Program EQ Q values	<i>11-E</i>	Sets the Q value for the EQ bands of the selected program (see "EQ Q setting" on page 28)	After pressing ENTER to select the menu, use the dial to select the band (<i>H</i> =high, <i>n</i> *=mid, <i>L</i> =low) and press ENTER . <i>R</i> low value of Q <i>n</i> <i>0</i> <i>r</i> Normal value of Q <i>b</i> high value of Q Value changes as selection is made. Press ENTER to confirm.	Use the left menu system for programs 1 and 3. Use the right menu system for programs 2 and 4.
Meter release time	<i>12-nr</i>	Sets the meter release time (see "Adjusting the output volume" on page 16).	<i>n</i> <i>0</i> <i>r</i> * Normal <i>5L0</i> Slow	Can be performed on both left and right menu systems.
Meter peak hold time	<i>13-nP</i>	Sets the meter peak hold time ("Adjusting the output volume" on page 16)	All values are in seconds <i>OFF</i> <i>0.5</i> <i>1.0</i> * <i>2.0</i>	Can be performed on both left and right menu systems.
Digital out	<i>14-d1</i>	Sets whether the signal from the digital output is pre- or post master fader	<i>n</i> <i>0</i> <i>r</i> * Post-fader signal <i>rEc</i> Pre-fader signal	Can be performed on both left and right menu systems.
Program fader curve	<i>15Fc</i>	Sets the fader curve as described and shown in "Program fader "curve"" on page 21.	After pressing ENTER to select the menu, use the dial to select the program fader to be set (<i>1</i> , <i>2</i> , <i>3</i> or <i>4</i>) and press ENTER . Select from the following: <i>R1</i> -6 dB <i>n</i> <i>0</i> <i>r</i> * -12 dB <i>R2</i> -24 dB Press ENTER to confirm.	Can be performed on both left and right menu systems.
Program fader reverse	<i>16Fr</i>	Sets the fader direction to reverse as described in "Program fader direction" on page 21.	After pressing ENTER to select the menu, use the dial to select the program fader to be set (<i>1</i> , <i>2</i> , <i>3</i> or <i>4</i>) and press ENTER . Select: <i>n</i> <i>0</i> <i>r</i> * Normal <i>rE4</i> Reverse Press ENTER to confirm.	Can be performed on both left and right menu systems.
Sampler tempo	<i>17St</i>	Sets the sampler playback pitch for either sampler 1 or sampler 2.	After pressing ENTER to select the menu, use the dial to select the sampler to be set (<i>51</i> *, or <i>52</i>) and press ENTER . Use the dial to select the value (from - <i>100</i> to <i>100</i>) and press ENTER to confirm.	Can be performed on both left and right menu systems. When sampler data is erased, the value is reset to 0%.

5 Menus

Function	Menu display	Meaning	Available settings	Notes
Mic balance	18bñ	Balances the microphone signal	(hard left) L9 to L1, n0r (center), r1 to r9 (hard right)	Can be performed on both left and right menu systems.
Program 1 balance	19b1	Balances the program 1 signal	(hard left) L9 to L1, c0 (center), r1 to r9 (hard right)	Can be performed on both left and right menu systems.
Program 2 balance	20b2	Balances the program 2 signal	(hard left) L9 to L1, c0 (center), r1 to r9 (hard right)	Can be performed on both left and right menu systems.
Program 3 balance	21b3	Balances the program 3 signal	(hard left) L9 to L1, c0 (center), r1 to r9 (hard right)	Can be performed on both left and right menu systems.
Program 4 balance	22b4	Balances the program 4 signal	(hard left) L9 to L1, c0 (center), r1 to r9 (hard right)	Can be performed on both left and right menu systems.
Restore factory presets	23FA	Restore all menu settings to their factory defaults.	Press ENTER . The display shows <i>SURE</i> . Press ENTER to restore factory defaults.	Can be performed on both left and right menu systems.
Clear all EQ memories	24Ac	Clears all EQ memories	Press ENTER . The display shows <i>SURE</i> . Press ENTER to clear the memories.	Can be performed on both left and right menu systems.
Clear all effect memories	25Ec	Clears all effect memories	Press ENTER . The display shows <i>SURE</i> . Press ENTER to clear the effect memories.	Can be performed on both left and right menu systems.

The X-9 faders are not all that they appear at first sight! Their behavior can be changed so that their “curve” can fit your way of working, so that they can

be pulled or pushed to increase the level, and they can also start and stop other devices connected to the X-9. See below for details.

Program fader “curve”

The fader “curve” decides how much the signal is cut then the fader is moved to the center position away from the “full on” position.

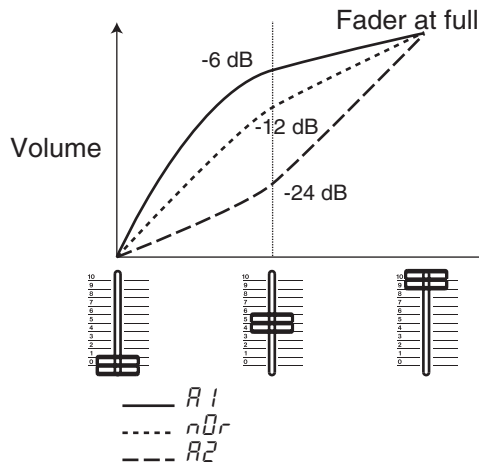

The program faders can be set individually (they do not all have to share the same setting).

The titles in this illustration refer to the explanation regarding setting as given in “Program fader curve” on page 19 (*15Fε*).

Program fader direction

As shipped, the faders on the X-9 work so that when you push them away from you, the level of the signal increases. When the faders are pulled towards you, the level decreases.

Some people prefer to work the other way round, so that pulling the faders towards you increases the volume. Each program fader can be set individually to work the way you prefer. See “Program fader reverse” on page 19 (*15Fε*) for details.

Alternatively, you can set fader reverse in the following way:

- 1 Press and hold down a **FUNCTION** key and the matching **ENTER** key together.
- 2 Press the **CUE** key of the program to toggle the fader direction, while holding down the two keys above. The **CUE** key lights when the fader is reversed.

NOTE

When the fader direction is reversed in this way, the fader start operation (see “Program fader direction” on page 21) is also reversed.

Fader start

The program faders can be used for automated start or stop of remote devices, using the fader start/stop jacks (see “Program faders” on page 8 for details of connections, etc.).

Whether the faders control the start/stop of the remote device is a menu setting, and you can enable or disable the fader start for each fader individually.

Alternatively, you can use the following method for setting fader start:

- 1 Press and hold down a **FUNCTION** key and the matching **ENTER** key together.
- 2 Press the program selection key (**PHONO/LINE/DIGITAL** or **INPUT/INPUT**) while holding down the two keys above to toggle fader start on or off. The selection key lights when fader start is enabled for the program.

Cross-fader curve

You can change the way in which the signal is changed from the A to B signals as the cross-fader is moved, using the **C.F CURVE** control.

When this control is fully counter-clockwise, it takes a relatively large movement of the cross-fader from

one side towards the center before the opposite cross-fader signal level is increased.

When this control is fully clockwise, the opposite cross-fader signal is heard after only a small movement of the cross-fader towards the center.

Cross-fader start

When either of the cross-fader start menus (*6cFA* or *7cFb*) has been set (is on, the **C.F START** switch is on the **ON** position) and a suitable connection has been made from the **FADER START** jack on the rear panel which corresponds to the program number selected), moving the cross-fader to the A and B source automatically starts that source.

Alternatively, press and hold down one of the **FUNCTION** keys and the corresponding **ENTER** key together.

While holding the **ENTER** and **FUNCTION** keys down, press the **EXT EFFECT** key to toggle cross-fader **A** start on or off.

While holding the **ENTER** and **FUNCTION** keys down, press the **STEREO/MONO SPLIT** key to toggle cross-fader **B** start on and off.

These methods are equivalent to the menu settings, and changing the settings in this way will also change the menu settings.

Use the **C.F START** switch in the **OFF** position to override the menu settings. In other words, if the switch is **OFF**, and the menu settings are on, cross-fader start is disabled. However, setting this switch to **ON** will not automatically enable cross-fader start if the menu setting is not set to on.



Cross-fader reverse

The **C.F REVERSE** switch is used to reverse the direction of the cross-fader.

When the switch is set to **ON**, the direction of the cross-fader is reversed (that is, mov-



ing it towards **A** makes the **B** signal louder and the other way round). The cross-fader start is also reversed (see “Cross-fader start” on page 22).

Use the two built-in effects units to add effects to the microphone, the four program signals, the samplers (see “Samplers” on page 26), or the master outputs.

NOTE

For details of connecting and using an external effects unit, see “External effect” on page 8.

The two internal effects units can be assigned to the following outputs:

EFFECT 1: microphone, programs 1 and 3 and sampler 1.

EFFECT 2: Programs 2 and 4, the master output, and sampler 2.

Assign the effects using the effect assignment controls (**EFFECT POSITION**), which determine where the effect will be used:

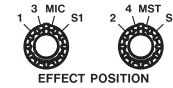

Turn the effects on and off using the **EFFECT** keys. It is also possible to set the footswitches to turn the effects on and off (“Footswitch assignment” on page 18).

Selecting the effect type

Select the effect type (either for effect 1 or effect 2) using the selection control:

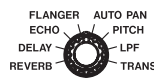

The available effects are:

REVERB	A reverberation to give an effect of space
DELAY	A repeat effect
ECHO	Another kind of repeat
FLANGER	A swirling sound
AUTO PAN	Pans the signal rhythmically from left to right and back again
PITCH	A pitch shifter effect
LPF	“Low pass filter”, sweeping up and down in a “wah-wah” effect.
TRANS	A choppy “transformation” effect.

Editing the effects

Each effect has two parameters which you can change to customize the sound¹:

LEVEL the level at which the effect works.

TIME The time factor which determines the sound of the effect (for example, the speed with which an auto-pan goes between channels)



The time parameter works in conjunction with the:

1. Except for the LPF effect, which has three parameters. See “Effect parameters” on page 24 for details.

BEAT parameter, and is used to synchronize the effect to the received beat of the music or allows manual setting of the timing. See below for details.

To set the **LEVEL** and **TIME** parameters:

- 1 Press the appropriate **EFFECT** key so that the indicator lights.
- 2 Press the **FUNCTION** key so that either the **LEVEL** or **TIME** indicator is lit.

If the **LEVEL** parameter is selected, use the **DATA** knob to set the level of the effect (see the table below).

If the **TIME** parameter is selected, use the **DATA** knob to set the parameter.

The BEAT parameter

If the “beat” mode is selected with the **EFFECT** key lit, the X-9 will make its best effort to determine the beat from the music being played from the sourced selected using the selectin control. This beat is then used as the basis for setting the effect time parameter.

Press **ENTER** to select the **BEAT** mode. The **BEAT** indicator lights.

In the “beat” mode, press the **ENTER** key as many times as necessary to select the ratio of the effect time to the beat (quarter-notes, etc.) as shown in the display.

7 Effects

Some music may have rather complex rhythms, and it may be unable to determine the beat automatically.

If the X-9 cannot determine the timing of the music automatically, you can use the **TAP** key to set the timing.



The **TAP** key can also be used to set the tempo used for the effect when the **EFFECT** key is not lit.

The different values obtainable here (1, 2, 4, 1/2, etc.) allow you to set up interesting rhythms matching the tempo of the music to the effect.

The **TAP** and **BPM** indicators under the display show whether the timing has been obtained manually (**TAP**) or automatically (**BPM**).

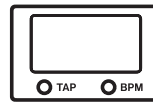

To exit the **BEAT** mode, turn the **DATA** knob to enter the time setting mode. Turning the knob again will edit the time value.

Effect parameters

The following are the parameters which may be set for the X-9's internal effects:

Effect name	LEVEL	TIME	BEAT
REVERB	0 to 100	0 to 100	—
DELAY	0 to 100	1 to 3,500 (ms)	2, 1, 3/4, 1/2, 1/4
ECHO	0 to 100	1 to 3,500 (ms)	2, 1, 3/4, 1/2, 1/4
FLANGER	0 to 100	10 ms to 16 s	32, 16, 8, 4, 2, 1 1/2
AUTO PAN	0 to 100	10 ms to 16 s	2, 1, 3/4, 1/2, 1/4

Effect name	LEVEL	TIME	BEAT
PITCH	0 to 100	-100% to +100%	—
LPF^a	0 to 100	10 to 1,000 (ms)	32, 16, 8, 4, 2, 1 1/2
TRANS	0 to 100	10 ms to 16 s	2, 1, 3/4, 1/2, 1/4

- a. The LPF has a third parameter, which is the frequency at which the filter operates. Press the **FUNCTION** key, so that the **LEVEL** and **TIME** indicators both light. Use the **DATA** knob to set this value from 0 to 100.

Storing effects

You can store up to 30 of each type of effect with the settings you have made in the X-9 (these settings are memorized, even when the power is turned off). This means 8 types of effect with 30 memories for each effect = 240 memories in total.

- 1 Make sure the **EFFECT** key is lit (if it is not, this procedure will not work).



- 2 Press and hold the **FUNCTION** key for about two seconds. The **MEMO** indicator blinks, and the display shows $\bar{n}E\bar{n}0$ (MEMO).

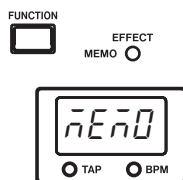

- 3 Press the **ENTER** key. The **MEMO** indicator now lights steadily, and number of the next empty "slot" for storing effects is shown in the display. Press the **EFFECT** key or changing the effect







If all the available slots have been filled, the display alternately shows *FULL* (FULL) and *!*.

- 4 Use the **DATA** knob to select the number of the slot to store the effect (if you don't want to use the empty one suggested by the X-9 or if you have to overwrite an existing setting). The number flashes in the display (or if all slots are full, the display alternately shows *FULL* (FULL) and the number you selected).
- 5 Press the **ENTER** key. If the slot is empty, the settings are stored in the slot, and the existing settings are overwritten. If there is data already in the slot, the display shows *SURE* (sure). Press **ENTER** to overwrite, **FUNCTION** to cancel.
- 6 Exit the store/recall mode by pressing the **FUNCTION** key for about 2 seconds or press-type with the effect selection control.

Recalling stored effect settings



There are two procedures, depending on whether the **EFFECT** key is lit or not.

If the **EFFECT** key is lit...

- 1 Press and hold the **FUNCTION** key for about two seconds. The display shows $\bar{n}E\bar{n}0$ (MEMO). 
- 2 Turn the **DATA** knob counterclockwise so that the effect **RECALL** indicator is flashing. 
- 3 Press the **ENTER** key. The **RECALL** indicator now lights steadily. 
- 4 Turn the **DATA** knob to choose between the numbers of the slots which have been filled (the numbers of empty slots are not shown) and $dFLt$ (dFLt—default).
- 5 Press the **ENTER** key to recall the settings. The effect is activated, and after one second, the X-9 returns to the “recalled” status in step 3. 

Alternatively:

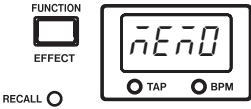
If the **EFFECT** key is *not* lit...

- 1 Press and hold the **FUNCTION** key for about two seconds. The **RECALL** indicator lights. 
- 2 Turn the **DATA** knob to choose between the numbers of the slots which have been filled (the numbers of empty slots are not shown) and $dFLt$ (dFLt—default). 
- 3 Press the **ENTER** key to recall the settings. The effect is activated (but cannot be heard until the **EFFECT** key is lit), and after one second, the X-9 returns to the “recall ready” status in step 2. 

In both cases:

Exit the store/recall mode by pressing the **FUNCTION** key for about 2 seconds *or* pressing the **EFFECT** key *or* changing the effect type with the effect selection control.

TIP

You can clear all stored effect settings using the menu system (25Ec). See “Clear all effect memories” on page 20 for details.

8 – Samplers

The two samplers can be used to record and play back samples of up to 8 seconds (each) in length.

The sample data is lost when the power to the X-9 is turned off.

Recording a sample

- 1 Select the source from which you will record the sampler.

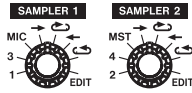

Sampler 1 can take samples from program 1 and program 3 as well as from the microphone. Set the **SAMPLER 1** selection control to 1, 3 or **MIC**.

Sampler 2 can take samples from program 2 and program 4 as well as from the master mix. Set the **SAMPLER 2** selection control to 2, 4 or **MST** (master).

NOTE

When recording samples, if the sample is recorded from a program or the master, the level is pre-fader (the fader has no effect on the level sent to the sampler) and if it is the microphone, the level is post-**LEVEL** (the microphone **LEVEL** control controls the level sent to the sampler).

- 2 Start playing the source.

- 3 Press the appropriate **IN** key to start the sample recording, and the **OUT** key to stop the sample recording (if you wait for eight seconds after pressing the **IN** key, recording of the sample stops automatically).

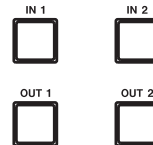

The **IN** and **OUT** keys light and flash to show when a point has been recorded.

A flashing key means that the key can now be pressed to set the point.

A lit key means that the point has been set.





TIP

When you have recorded a sample, you must change the sampler selection control to one of the playback modes listed below in "Playing back samples" on page 26 before you can hear it.

Also note that you can use the footswitches in place of the **IN** and **OUT** keys, using the menu option **FFFL**. See "Footswitch assignment" on page 18.

Playing back samples

The **SAMPLER 1** and **SAMPLER 2** selection controls have four settings each controlling playback:

	Forward playback ("single shot")
	Looped forward playback
	Reverse playback ("single shot")
	Reverse looped playback

sampler output is sent straight to the master.

Play back the sample by pressing the appropriate **IN** key, and stop playback (in the case of looped samples) by pressing the **OUT** key.

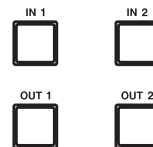

You can also stop sample playback before the end of the sample by pressing the **OUT** key.

If you press the **IN** key before the sample has finished playing, playback starts again from the start of the sample.

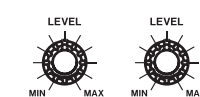

Adjust the final output level with the sampler's **LEVEL** control.

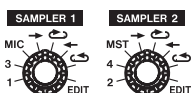

ASSIGN A
Note that this is **SAMP1** for the **ASSIGN A** control

Turn the selection control to the playback type you want to use for the sampler.

You can select sampler 1 as the A output or sampler 2 as the B output. If the sampler is not assigned to one of the cross-fader input signals, the



If you want to preview the playback, use the **SAMPLER CUE** key (see “Cross-fading” on page 14).

Editing samples

By *editing* samples, we mean here the adjustment of the start and end points of the sample.

When the **SAMPLER 1** or **SAMPLER 2** selection control is turned to **EDIT**, the sample can be edited (if both are left in the **EDIT** position, only sampler 1 can be edited).

Use the left **DATA** knob to adjust the start point of the sample (of course you can only adjust it forward from the original **IN** point).

Use the right **DATA** knob to adjust the end point of the sampler (of course, you can only adjust the position backward from the original **OUT** point).

Naturally, the end point of the sample must come after the start point.

TIP

*Don't forget to turn the sampler selection control away from the **EDIT** position when you've finished editing.*

NOTE

When you are editing samples, you cannot turn the effect on or off.

Erasing samples

When a sample has been recorded, (both the **IN** and **OUT** keys are lit), you can erase the contents of the sample.

Press the **IN** and **OUT** keys together to erase the contents of the sampler.

Sample pitch

The sampler pitch and tempo can be altered by $\pm 100\%$ using the menu system (*175t*).

See (“Sampler tempo” on page 19) for details.

9 – EQ

Each program has three bands of sweepable EQ with adjustable Q available for changing the way that the signal sounds.

Up to 100 settings can be stored, and recalled for later use.

Even if the settings were stored for one program, they can be recalled and used again with another program.

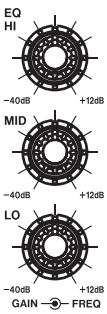

The controls for each program consist of three dual knobs.

The inner knob controls the amount (**GAIN**) that the signal is cut or boosted for the appropriate band. Turn clockwise to boost, counterclockwise to cut.

The amount that the signal is cut can be up to 40 dB of cut, and it can be boosted by up to 12 dB in each band.

The outer knob of each pair (**FREQ**) controls the frequency on which the band works. Turn clockwise to affect a higher frequency, counter-clockwise to affect a lower frequency.

The **HIGH** (treble) band can be set to a value between 6 kHz (6,000 Hz) and 20 kHz (20,000 Hz).

The **MID** (mid-range) band can be set to a value between 200 Hz and 6 kHz (6,000 Hz).

The **LOW** (bass) band can be set to a value between 20 Hz and 200 Hz.

WARNING

*If you turn the **GAIN** of all bands to a boost signal, you may overload the X-9 and your amplifier, resulting in distortion. "Back off" using the **TRIM** control if this occurs.*

EQ Q setting

The 'Q' of EQ is how much of the signal is affected by the equalization.

The higher the Q value, the sharper the EQ curve (and the smaller part of the signal affected by the EQ).

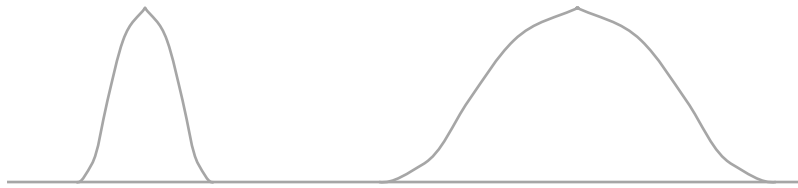

High Q value
(*b* setting)

(Low Q value
R setting)

There are three Q values, which may be set for each band using the menu system (see "Program EQ Q values" on page 19 (*11-E*) for details).

The three settings are *R* (low Q), *nor* (normal setting) and *b* (high Q).

Cutting the EQ bands

If you want to make an instant cut of 40 dB in one of the bands, use one of the sets of **LO CUT**, **MID CUT** and **HI CUT** controls to cut the appropriate band (when the switch is down, the band is cut).



NOTE

These controls do not affect the input programs directly—they affect the signal assigned to the A and B cross-fade signals.

These controls do not affect the sampler outputs.

Viewing EQ settings

Because its EQ circuits are digital, the X-9 allows you to see the exact figures associated with an EQ setting (for instance, 12 dB of cut at 400 Hz, etc.).

The EQ settings can be viewed for any of the four programs (but not for the microphone, whose EQ settings cannot be memorized and recalled).

The left display and controls can be used for programs 1 and 3, and the right for programs 2 and 4.

Use the selector switches to select the program.



Use the menu controls corresponding to the selector switch to view the settings for the equalization.

Note that the **MONITOR** setting has no meaning in this mode.

When the **EFFECT** key is off, and no menu settings are being made, turn the **DATA** knob until the **HI**, **MID** or **LOW** indicator is lit. The display shows the frequency currently set for the program.

Turning either the gain or the frequency control for the band changes the display to either the frequency or the gain for that band.

Remembering and recalling EQ settings

The menu system is used to store the EQ settings of the currently-selected program.

Use either the left or the right menu system for this function, depending on the program. The left display and menu system are used for programs 1 and 3, and the right display and menu system are used for programs 2 and 4.

See “EQ memory store” on page 18 and “EQ memory recall” on page 18 about menu functions \square and \square for an explanation of how these are stored and recalled to the 100 memory banks.

All memories can be erased using the menu system (see “Clear all EQ memories” on page 20— \square).

10 – Specifications, etc.

I/O specifications

Audio I/O

Analog inputs

LINE 1 through LINE 4	RCA pin (unbalanced)
Input level	-16 dBV
Input impedance	47 k Ω
PHONO 1 through PHONO 4	RCA pin unbalanced (with additional SIGNAL GND connector)
Input level	-54 dBV
Input impedance	47 k Ω
MIC input	XLR balanced (female) ^a
Input level	-55 dBV
Input impedance	2.7 k Ω
RETURN (L, R)	1/4" jack (unbalanced)
Input level	-10 dBV
Input impedance	22 k Ω

Analog outputs

MASTER OUTPUT (BALANCED)	XLR balanced (male) ^a
Output level	+ 4dBu
Output impedance	75 Ω
MASTER OUTPUT (UNBALANCED)	RCA pin (unbalanced)
Output level	-10 dBV
Output impedance	1 k Ω
BOOTH OUTPUT	RCA pin (unbalanced)
Output level	-10 dBV
Output impedance	1 k Ω
SEND (L, R)	1/4" jack (unbalanced)
Output level	-10 dBV
Output impedance	1 k Ω
PHONES (x 2)	Stereo 1/4" jack
Maximum total output level	30 mW + 30 mW
Total load impedance	32 Ω

Digital inputs

CH 1, CH 2	RCA pin, IEC60958 TYPE I or TYPE II (auto-detect)
-------------------	---

Digital output

DIGITAL OUT	RCA pin, IEC60958 TYPE II (SPDIF)
--------------------	-----------------------------------

a. All XLR connectors are wired 1=ground, 2-live (hot), 3=return (cold)

Control I/O

FADER STOP/START 1 through 4	3.5 mm mini-jack (high=5 V, Low (on)=0 V) Tip=PLAY, GND=READY
FOOT SW 1, FOOT SW 2	1/4" jack (for use with RC-30P)

Audio specifications

Program equalization	
HIGH (frequency range)	6 kHz to 20 kHz
gain	-40 dB to +12 dB
MID (frequency range)	200 Hz to 6 kHz
gain	-40 dB to +12 dB
LOW (frequency range)	20 Hz to 200 Hz
gain	-40 dB to +12 dB
Microphone equalization	
HIGH (frequency range)	10 kHz
gain	-12 dB to +12 dB
LOW (frequency range)	100 Hz
gain	-12 dB to +12 dB
Frequency response	
LINE	20 Hz to 20 kHz ± 2.0 dB
PHONO	20 Hz to 20 kHz ± 2.0 dB
MIC	20 Hz to 20 kHz ± 2.0 dB
Signal-to-noise ratio	
PGM	84 dB (IHF A weighting)
PHONO	77 dB (IHF A weighting)
MIC	70 dB (IHF A weighting)
Total harmonic distortion	
LINE	< 0.025%
PHONO	< 0.035%
MIC	< 0.040%
Crosstalk	> 70 dB @ 1 kHz
Samplers (1 and 2)	8 seconds of record/playback per sampler
Effector memories	30 x 8 (types) = 240 memories
EQ memories	100

General specifications

Voltage requirements	USA/Canada 120 VAC, 60 Hz U.K./Europe 230 VAC, 50 Hz Australia 240 VAC, 50 Hz General export 120 VAC, 60 Hz, 230 VAC, 60 Hz
Power consumption	42 W
Applicable electromagnetic environment	E4
Peak inrush current	0.9 A
Dimensions (w x d x h)	320 x 354 x 87(mm) 12.6 x 13.9 x 3.4 (in)
Weight	7 kg (15.4 lb.)
Operating temperature	5°C to 35°C (41°F to 95°F)
Supplied accessories	Rack-mounting ears Rack-mounting kit Fan cover Eight RCA plug covers
Optional accessories	MIDI/Digital Out board

Dimensional drawing

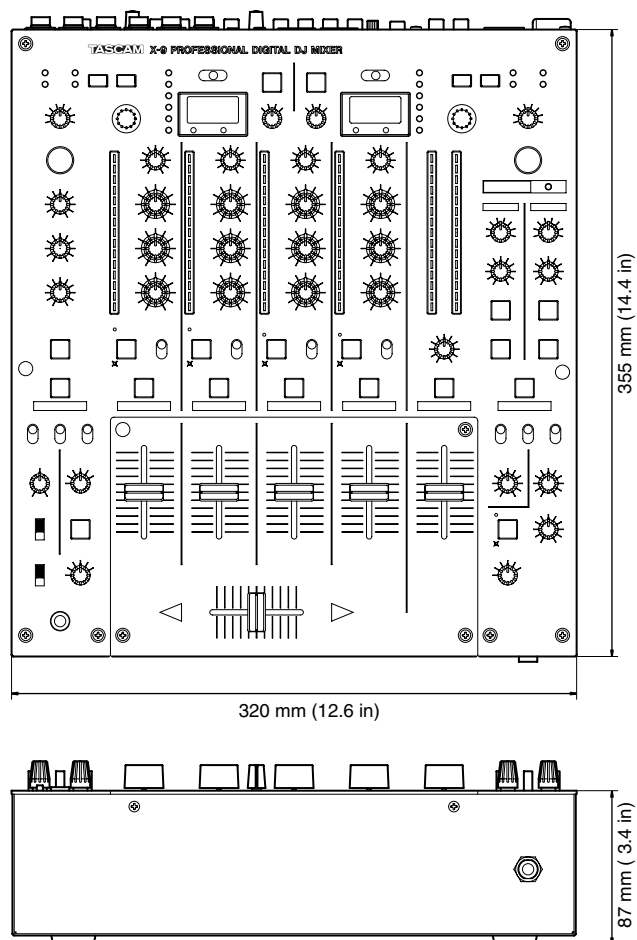

Mounting the X-9 in a rack

When mounting the X-9 in a 19" rack, use only the supplied rack-mount ears and mounting screws, etc.

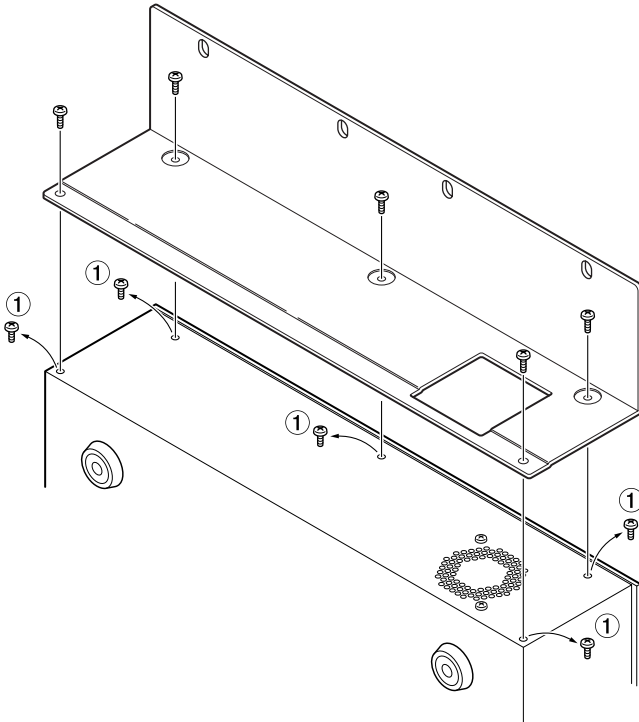

As shown here, remove the five screws (1) on the left side of the unit.

Locate and fit the left rack-mount angle (with the fan cutout) and fasten it to the X-9 using the five screws removed in the previous step.

Fit the right rack-mount angle in the same way.

Case mounting

WARNING

It is most important that if you are mounting the X-9 in a rack or in a case, that the supplied fan cover and ventilation cover are fitted as explained here. This ensures a smooth airflow, and prevents the fan and ventilation vents from being blocked, which could cause overheating and damage to the X-9.

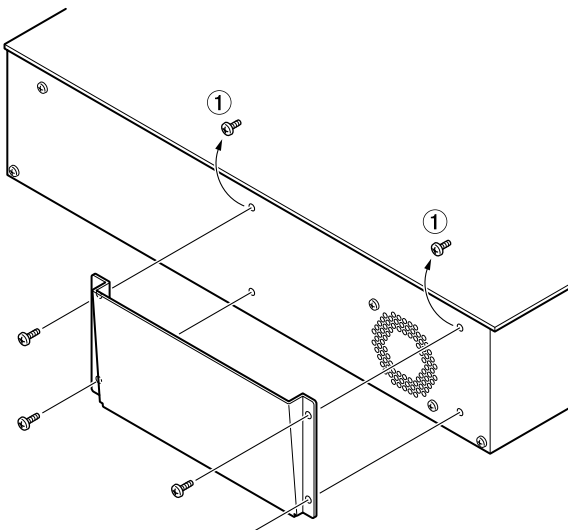

Remove the two screws (1) on the left side of the X-9 as shown here.

Use the four screws supplied with the fan cover to attach the fan cover.

Repeat the process for the ventilation cover on the right side of the X-9.

10 Specifications, etc.

Block diagram

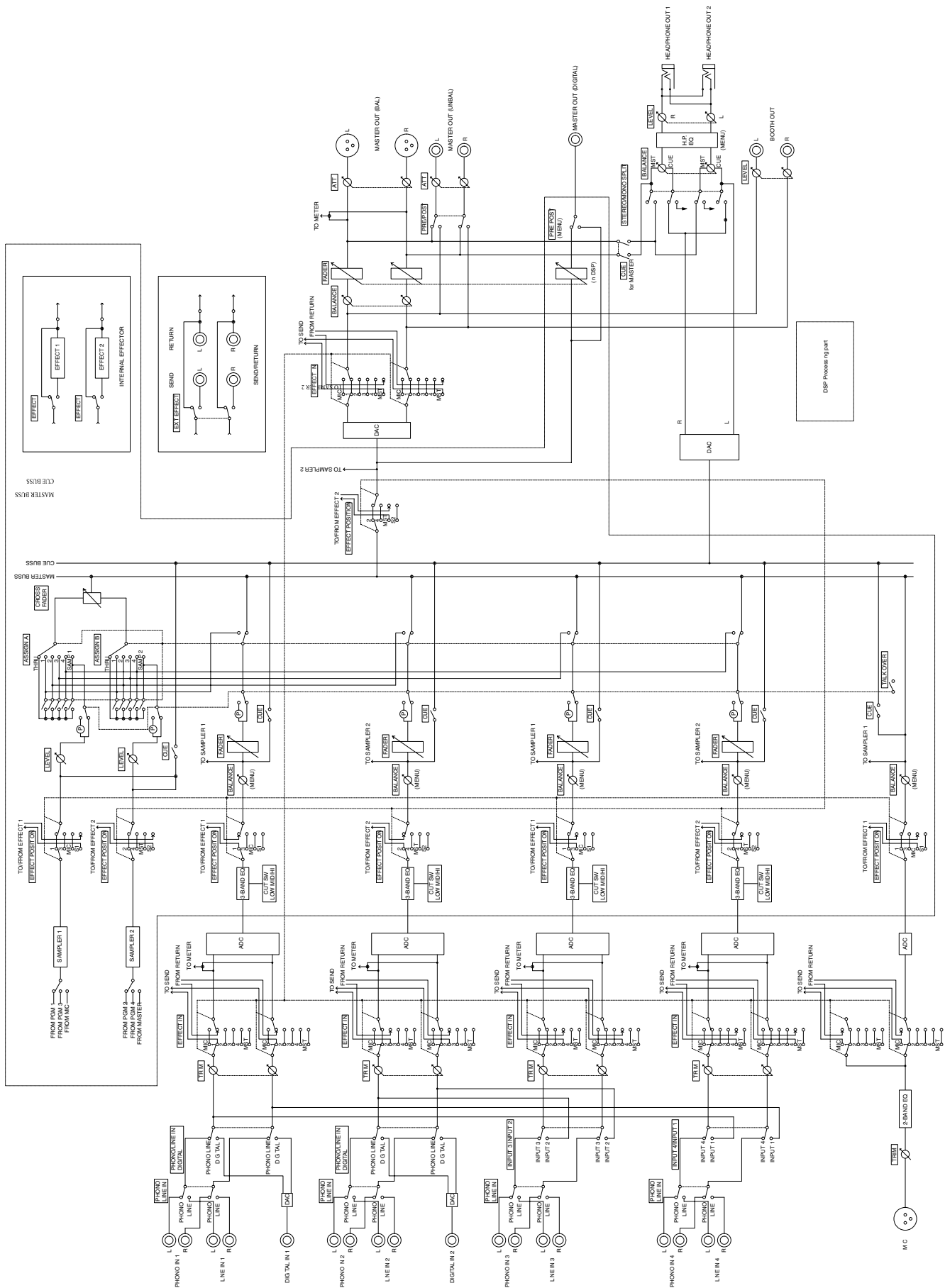

TASCAM

TEAC Professional Division

X-9

TEAC CORPORATION

Phone: (0422) 52-5082

3-7-3, Nakacho, Musashino-shi, Tokyo 180-8550, Japan

TEAC AMERICA, INC.

Phone: (323) 726-0303

7733 Telegraph Road, Montebello, California 90640

TEAC CANADA LTD.

Phone: 905-890-8008 Facsimile: 905-890-9888

5939 Wallace Street, Mississauga, Ontario L4Z 1Z8, Canada

TEAC MEXICO, S.A. De C.V

Phone: 5-851-5500

Campesinos No. 184, Colonia Granjes Esmeralda, Delegacion Iztapalapa CP 09810, Mexico DF

TEAC UK LIMITED

Phone: 01923-819699

5 Marlin House, Croxley Business Park, Watford, Hertfordshire. WD1 8TE, U.K.

TEAC DEUTSCHLAND GmbH

Phone: 0611-71580

Bahnstrasse 12, 65205 Wiesbaden-Erbenheim, Germany

TEAC FRANCE S. A.

Phone: 01.42.37.01.02

17 Rue Alexis-de-Tocqueville, CE 005 92182 Antony Cedex, France

TEAC BELGIUM NV/SA

Phone: 0031-162-510210

Oeverkruid 15, NL-4941 VV Raamsdonksveer, Netherlands

TEAC NEDERLAND BV

Phone: 0162-510210

Oeverkruid 15, NL-4941 VV Raamsdonksveer, Netherlands

TEAC AUSTRALIA PTY.,LTD. A.B.N. 80 005 408 462

Phone: (03) 9672-2400 Facsimile: (03)9672-2249

280 William Street, Port Melbourne, Victoria 3000, Australia

TEAC ITALIANA S.p.A.

Phone: 02-66010500

Via C. Cantù 11, 20092 Cinisello Balsamo, Milano, Italy